

5 Main Components

Unlimited Configurations

ERECTASTEP



Why buy ErectaStep?

- ✓ **1. Completely Universal** – design for your custom needs – allows for units to be repurposed later in different configurations.
- ✓ **2. Pre-engineered components** – you save custom engineering costs.
- ✓ **3. Safety compliance built into the product** – Lowers your risk of ownership and increases safety.
- ✓ **4. Costs less than custom fabrication.**
- ✓ **5. In stock and ready to ship!**

Crossovers

E-2

Safety made simple.

The ErectaStep system is ideal for crossovers which allow safe and easy access over pipes, dike walls and other obstructions. ErectaStep provides up to 9' of horizontal clearance without tower supports (three platforms) or infinite horizontal clearance with tower supports. To design your crossover, measure your vertical and horizontal clearance and refer to the chart on the last page of this catalog to determine which stair model and how many modular platforms you will need. If you ever have any questions, please feel free to call one of our experienced customer service representatives or send us a picture of your work area so we can design the crossover that will best suit your needs.



Each component is proudly crafted in our South Carolina facility.



Crossover Configuration Example 1

PARTS USED: 2 STAIR UNITS (11389), 2 HANDRAILS (11395), 1 PLATFORM (11394)

This configuration provides 3' horizontal and 39" vertical clearance.

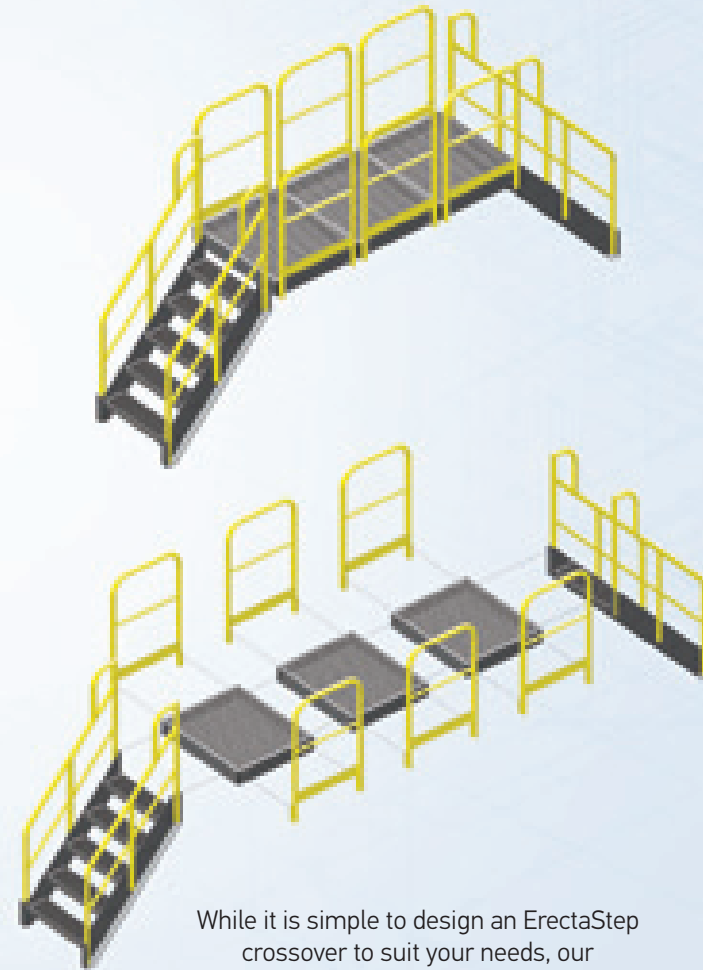

While it is simple to design an ErectaStep crossover to suit your needs, our customer service representatives are available to help with your design.



Crossover Configuration Example 2

PARTS USED: 2 STAIR UNITS (11390), 4 HANDRAILS (11395), 2 PLATFORMS (11394)

This configuration provides 6' horizontal and 48" of vertical clearance.



Crossover Configuration Example 3

PARTS USED: 2 STAIR UNITS (11387), 6 HANDRAILS (11395), 3 PLATFORMS (11394)

This configuration provides 9' horizontal and 21" of vertical clearance.

E-3

Example Configurations

E-4

Limitless designs.

Configurations are endless and limited only by your imagination. Call us for any assistance.



Each component is proudly crafted in our South Carolina facility.



Example Configuration 1

PARTS USED: 2 STAIR UNITS (11388), 2 PLATFORMS (11394), 5 HANDRAILS (11395), 1 6/TOWER (11383), 1 3/TOWER (11380)

This work platform system allows specific access to parts such as valves or filters which require repeated access.



Example Configuration 2

PARTS USED: 2 STAIR UNITS (11388), 3 PLATFORMS (11394), 6 HANDRAILS (11395), 2 TOWERS (11380)

This "L" shaped crossover configuration allows for safe and easy travel over areas such as assembly lines.



MANUFACTURED USING PRECISION LASER TECHNOLOGY

Example Configuration 3

PARTS USED: 1 1-STEP STAIR UNIT (11386), 1 3-STEP STAIR UNIT (11388), 1 4-STEP STAIR UNIT (11389), 6 PLATFORMS (11394), 13 HANDRAILS (11395), 2 1/TOWERS (11378), 2 5/TOWERS (11382), 2 7/TOWERS (11384)

This platform provides safe access to upper levels within a confined space, such as the mezzanine level of a warehouse.

Example Configuration 4

PARTS USED: 1 STAIR UNIT (11388), 1 PLATFORM (11394), 3 HANDRAILS (11395), 1 TOWER (11380)

This small platform allows for easy, permanent access to elevated work areas – a safe replacement for wobbly ladders, work stands or footstools.



Example Configurations

E-6

Limitless designs.

Configurations are endless and limited only by your imagination. Call us for any assistance.



Each component is proudly crafted in our South Carolina facility.

Multiple tiers of varying heights require no engineering or supplemental components and can be assembled in any configuration imaginable.



While raised platforms require a tower support opposite of stair, support location is flexible.



**MANUFACTURED USING
PRECISION LASER TECHNOLOGY**

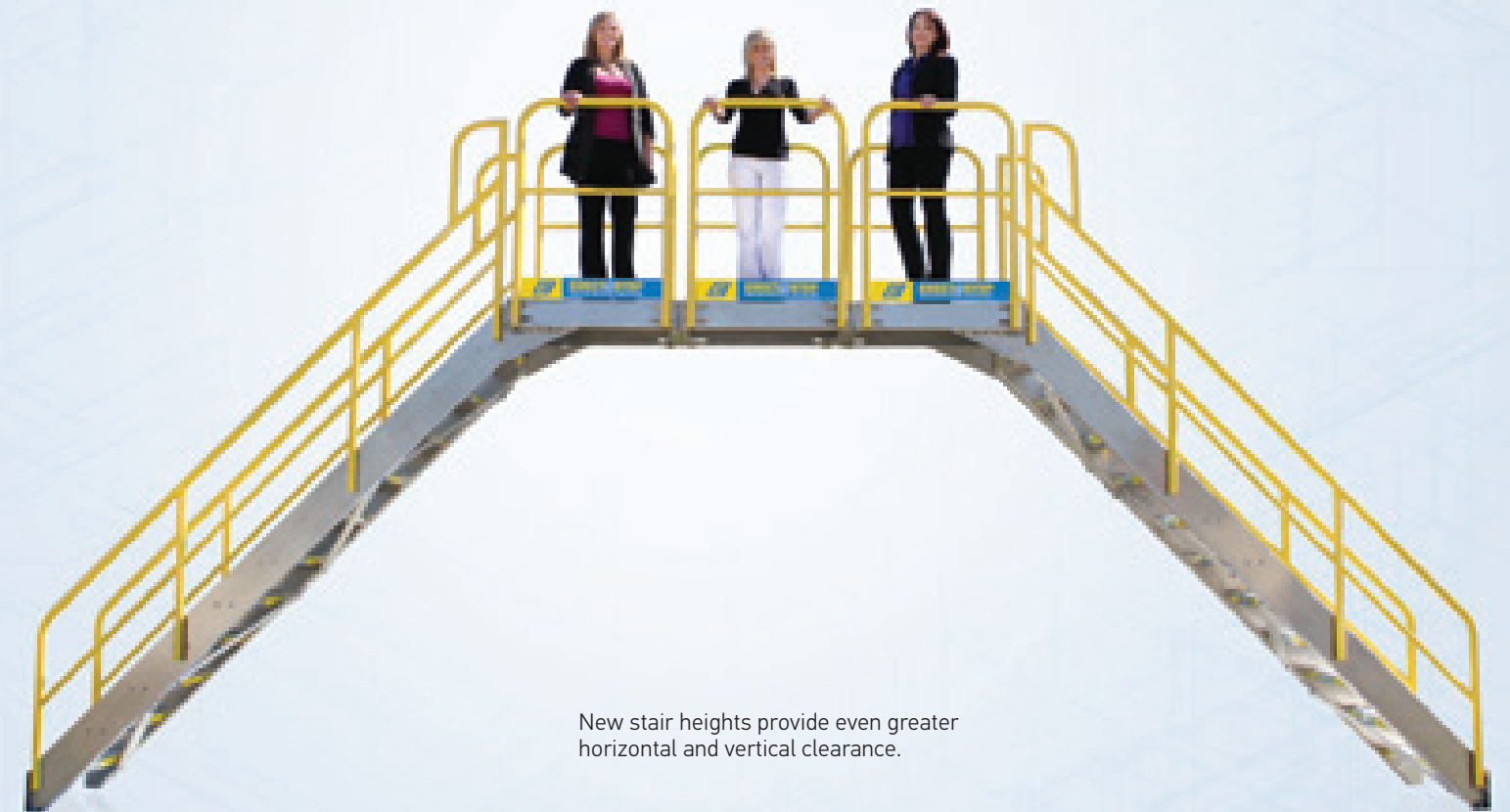

New stair heights provide even greater horizontal and vertical clearance.

Example Configurations

Ladder Configurations

E-8

90° Multi-directional Conveyor Crossover

PARTS USED: 2 8-STEP STAIR UNITS (11939), 1 UNIVERSAL PLATFORM (11394), 1 8-TOWER SUPPORT (11385), 2 SAFETY HANDRAIL (11935)



Maintenance Access Platform

PARTS USED: 2 3-STEP STAIR UNITS (11388), 2 UNIVERSAL PLATFORMS (11394), 5 SAFETY HANDRAILS (11395), 1 6-TOWER SUPPORT (11383), 1 3-TOWER SUPPORT (11380)



Built for strength.

Our new ladder components are available in eleven sizes, from one to eleven steps and bolt to the bottom of any ErectaStep platform with no supplemental parts or engineering. Each ladder also functions as a support tower. ANSI yellow powder coating on handrails meet OSHA safety requirements and provide a durable finish.



Each component is proudly crafted in our South Carolina facility.



MANUFACTURED USING PRECISION LASER TECHNOLOGY

NEW COMPONENT

The Ladder Component provides greater flexibility when providing access to elevated platforms.

Rolling Dolly Configurations

E-10

Make your platform mobile.

Custom engineered dolly kits can make virtually any platform go where you need it, when you need it. With the limitless configurations you can design the perfect system to fit your needs. Contact our team for additional design and configuration needs.



**MANUFACTURED USING
PRECISION LASER TECHNOLOGY**



The Dolly Component makes ErectaStep the most robust rolling platform available.



Dolly Components are available for all stair heights.



Each component is proudly crafted in our South Carolina facility.

Universal Platform Design

E-12

Customization is king.

ErectaStep's universal 3' x 3' platform design is infinitely expandable through common bolt hole patterns found on each side of the platform. Attaching platforms, stairs or ladders is accomplished with only a ratchet and an open ended wrench. No additional support is required for spans of 9 feet (3 platforms). When joining more than 4 platforms tower supports are required and bolt easily to the bottom of one or multiple platforms, regardless of stair location. Platforms feature a stamped, slip resistant surface which provides solid traction. Each platform is manufactured with stamping technology to increase strength and lower costs by eliminating welds. Our use of robotic welding for the few remaining joints results in strong, precise welds on every platform shipped.

Universal Platform Unit PART NO. 11394

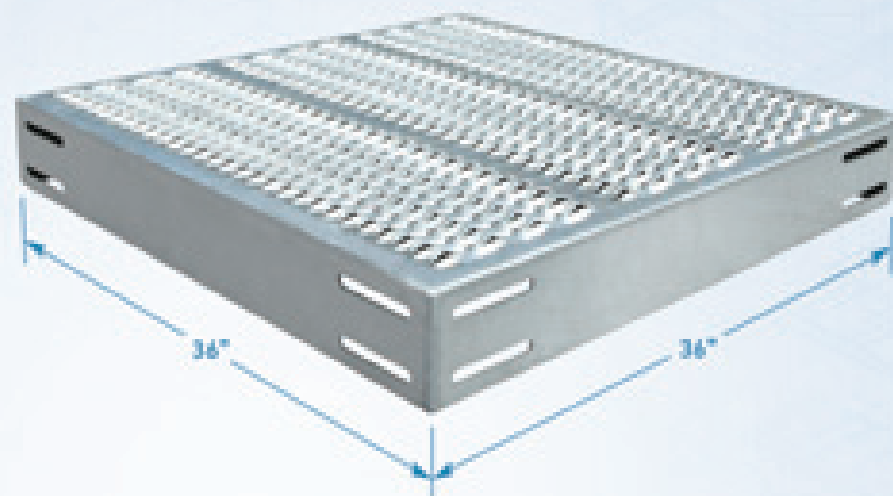

PLATFORM IS IDENTICAL ON ALL 4 SIDES

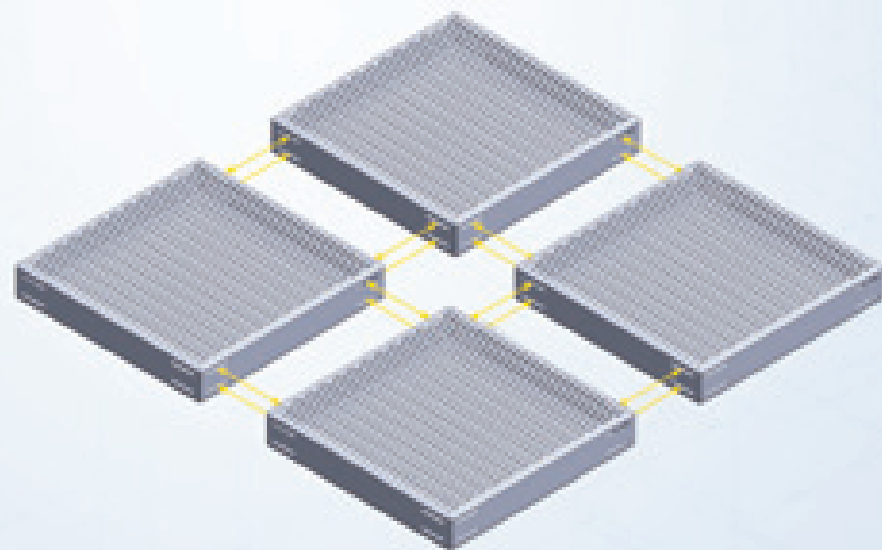

PLATFORMS EASILY BOLT TOGETHER TO MAKE A LARGER PLATFORM



MANUFACTURED USING PRECISION LASER TECHNOLOGY

3' x 12' Platform Configuration

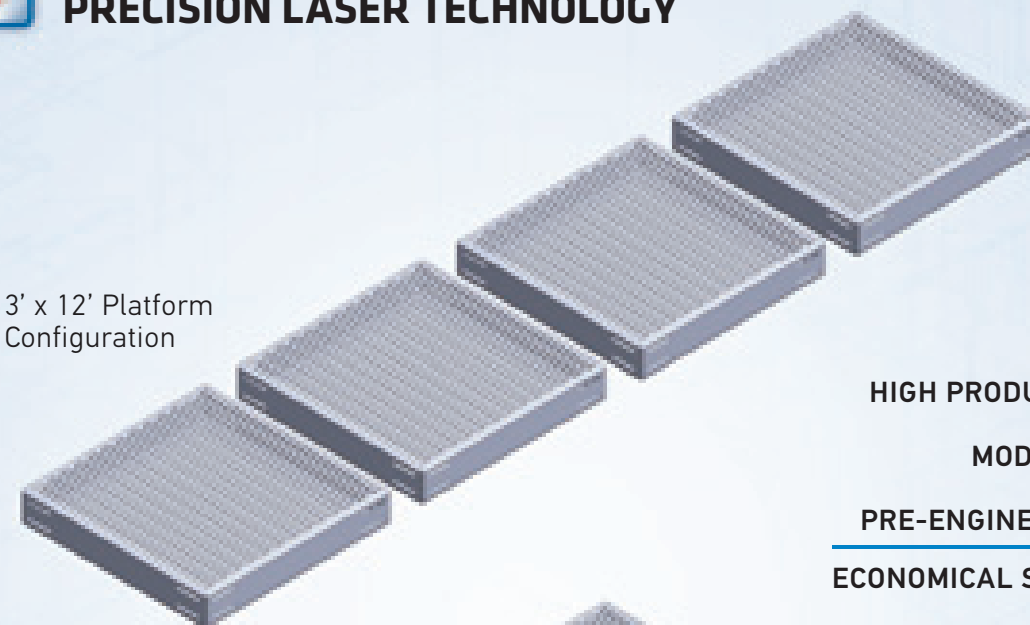

HIGH PRODUCTION RUNS
 X
 MODULAR
 X
 PRE-ENGINEERED DESIGN
 ECONOMICAL SAVINGS TO YOU

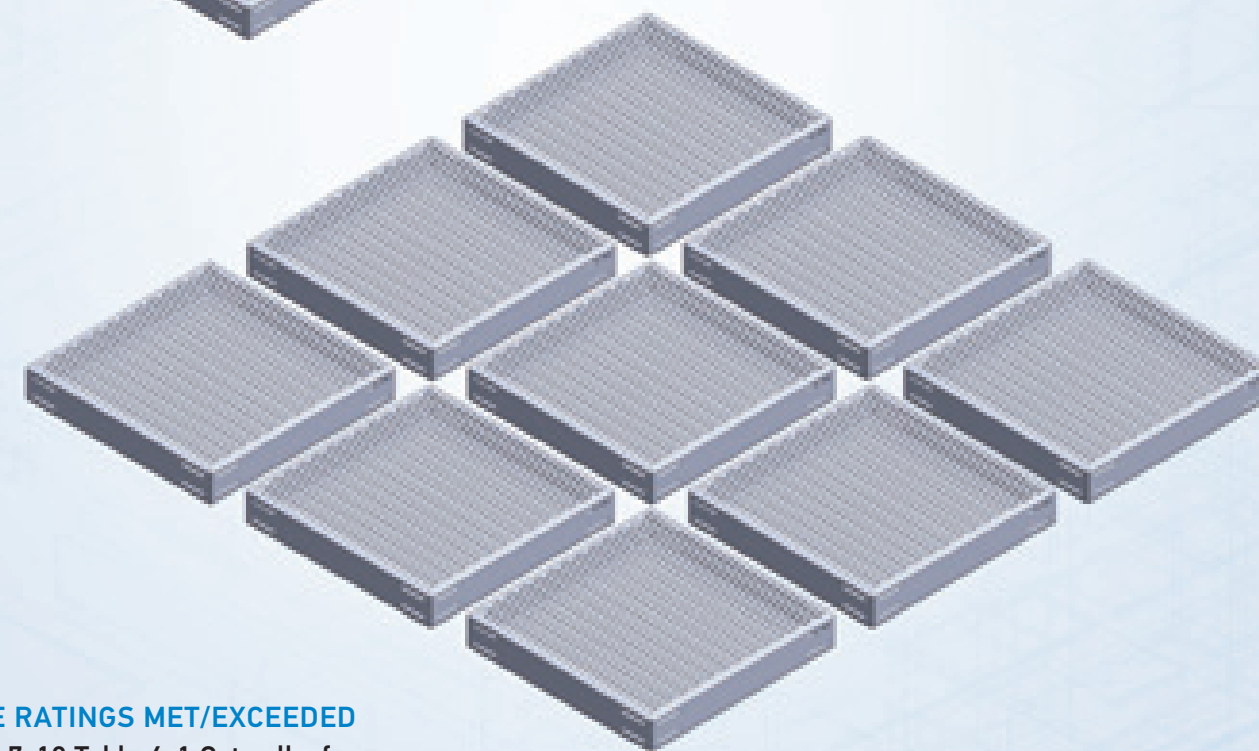

9' x 9' Platform Configuration

CODE RATINGS MET/EXCEEDED
 ASCE 7-10 Table 4-1 Catwalks for
 maintenance access = 40 PSF



Each component is proudly crafted in our South Carolina facility.

► DESIGN LOAD: 50 PSF

PATENT PENDING

Safety Handrails

E-14

Ease of use.

ErectaStep Safety Handrails come in one standardized size and share a bolt hole pattern with the universal platform, allowing the handrails to attach to any side of the platform. Constructed of round pipe with an outer diameter of slightly less than 2" and powder coated ANSI safety yellow, these handrails are robust in strength as well as appearance.



Each component is proudly crafted in our South Carolina facility.

PATENT PENDING



Safety Handrail PART NO. 11395



Three handrail sections shown on each side of this crossover unit bolt up consecutively to their respective platforms, allowing for safe passage over workplace obstructions.

HANDRAILS AND STAIRS SHARE THE SAME BOLT HOLE PATTERN

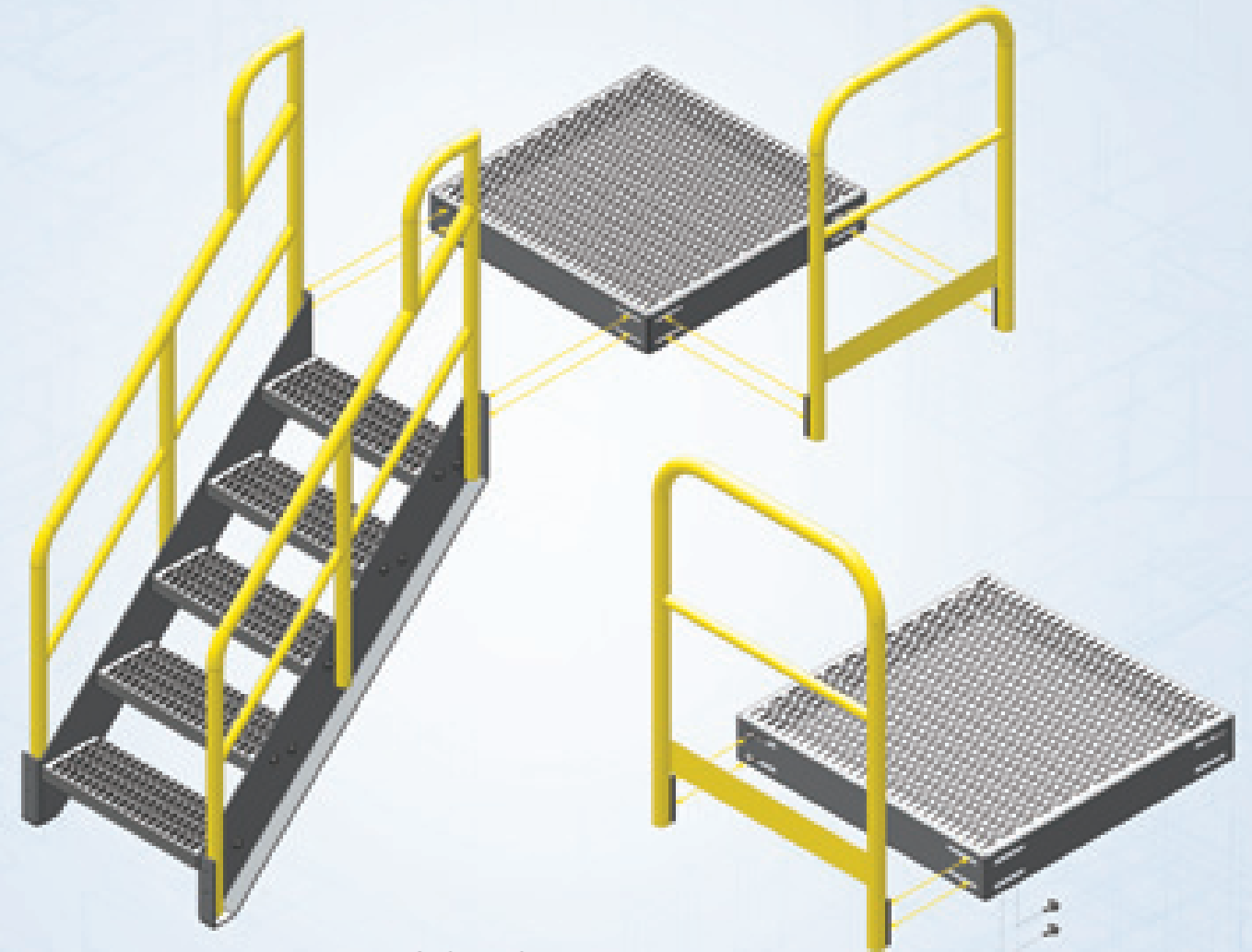

▶ DESIGN LOAD: 200 LBS. IN ANY DIRECTION

Safety Stairs

E-16

A step up in quality.

ErectaStep stair units come in 9" vertical increments with 26" of walk surface and slip resistant tread. To meet OSHA regulations, handrails are powder coated ANSI safety yellow. Stairs bolt to any side of the universal platform, allowing for easy customization. Stair units ship broken down for low shipping costs and are easy to assemble. Please see the spec sheet on page E-30 for dimensions on all stair sizes.

PATENT PENDING



1-Step Safety Stair
Part No. 11386

2-Step Safety Stair
Part No. 11387

3-Step Safety Stair
Part No. 11388



Each component is proudly crafted in our South Carolina facility.

► **DESIGN LOAD:**
1000 LBS. MOVING LOAD

STAIR BOLTS TO ANY OF THE 4 SIDES OF THE UNIVERSAL PLATFORM



4-Step Safety Stair
Part No. 11389

5-Step Safety Stair
Part No. 11390

6-Step Safety Stair
Part No. 11391

7-Step Safety Stair
Part No. 11392



8-Step Safety Stair
Part No. 11393

9-Step Safety Stair
Part No. 11465

10-Step Safety Stair
Part No. 11466

11-Step Safety Stair
Part No. 11467

NEW COMPONENT

NEW COMPONENT

NEW COMPONENT

Tower Supports

Built for strength.

ErectaStep support towers use an anchor bolt hole design that match up with the bolt-hole pattern on the bottom of the universal platform, allowing for three bolt-up scenarios: 1) a single tower bolting to a single platform; 2) bolting two platforms on either side of a support tower; and 3) bolting support towers on multiple sides of the same platform. Support towers are necessary when using more than 3 platforms in succession. Each leg of support must be supported to grade adequately.

PATENT PENDING



**MANUFACTURED USING
PRECISION LASER TECHNOLOGY**



Each component is proudly crafted in our South Carolina facility.

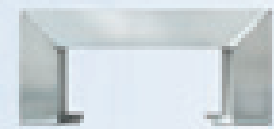

Tower Support 1
Part No. 11378

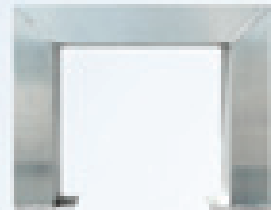

Tower Support 2
Part No. 11379



Tower Support 3
Part No. 11380



Tower Support 4
Part No. 11381



Tower Support 5
Part No. 11382



Tower Support 6
Part No. 11383

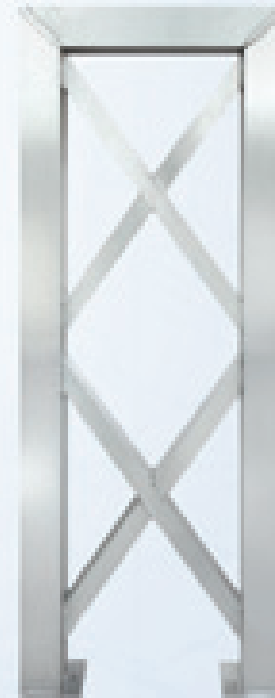

Tower Support 7
Part No. 11384



Tower Support 8
Part No. 11385



Tower Support 9
Part No. 11468

NEW COMPONENT



Tower Support 10
Part No. 11469

NEW COMPONENT



Tower Support 11
Part No. 11470

NEW COMPONENT

Ladder Units

E-20

Versatility defined.

Our new ladder components are available in eleven sizes, from one to eleven steps and bolt to the bottom of any ErectaStep platform with no supplemental parts or engineering. Each ladder also functions as a support tower. ANSI yellow powder coating on handrails meet OSHA safety requirements and provide a durable finish.

PATENT PENDING

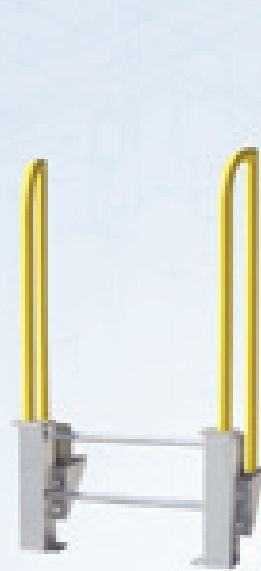

1-Step Ladder Unit
Part No. 11457

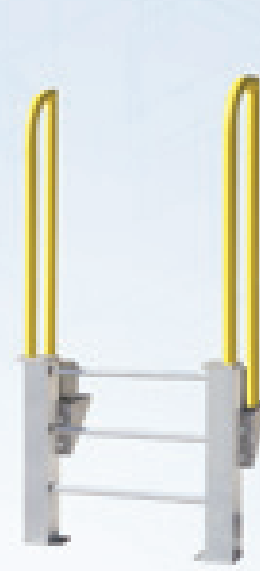

2-Step Ladder Unit
Part No. 11458

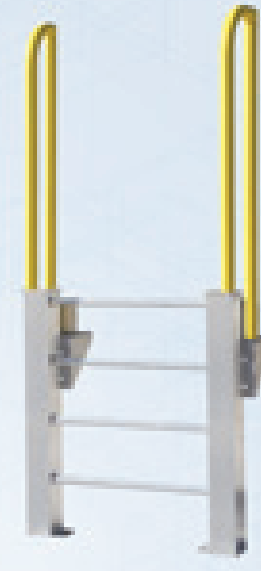

3-Step Ladder Unit
Part No. 11459

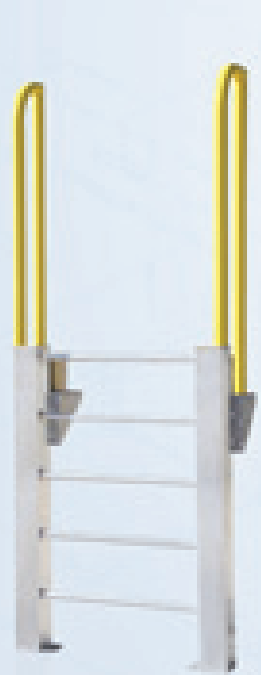

4-Step Ladder Unit
Part No. 11460



5-Step Ladder Unit
Part No. 11461



6-Step Ladder Unit
Part No. 11462



7-Step Ladder Unit
Part No. 11463



8-Step Ladder Unit
Part No. 11464



9-Step Ladder Unit
Part No. 11488



10-Step Ladder Unit
Part No. 11489



11-Step Ladder Unit
Part No. 11490



**MANUFACTURED USING
PRECISION LASER TECHNOLOGY**



Each component is proudly crafted in our South Carolina facility.

Application Examples

E-22

ErectaStep is ideal for creating crossovers, raised walkways and equipment access and service platforms.



Long catwalk platform system for compressor stations make installation simple and timely.



Multiple entry and exit make an ideal problem solving solution.

Application Examples

E-24

ErectaStep is ideal for creating crossovers, raised walkways and equipment access and service platforms.



Eight stair pipe crossover.



This ten stair platform provides 360 degree access.



Four stair berm crossover.



Two problems, same solution: ErectaStep.



Rooftop access to solar and air conditioning units.

Application Examples

E-26

ErectaStep is ideal for creating crossovers, raised walkways and equipment access and service platforms.



Five step service platform.



Two step trailer access.



Configure handrail placement for access as required.



Complex crossover with multiple access points.



The components from this crossover can be re-purposed as the plant grows.

Application Examples

E-28

ErectaStep is ideal for creating crossovers, raised walkways and equipment access and service platforms.



30" vertical clearance, 9' span over pipes.



Create solutions to complex platform needs over or through machines.



Pump station access was an afterthought.



Platform allowing access to two sides of pumps.



ErectaStep crossover system safely spans 9' without the need for additional support.
Parts used: 2 3-Step Stair Units (11388), 3 Universal Platforms (11394), 6 Safety Handrails (11395)

Specifications

OSHA Regulations/Terms and Conditions

E-30

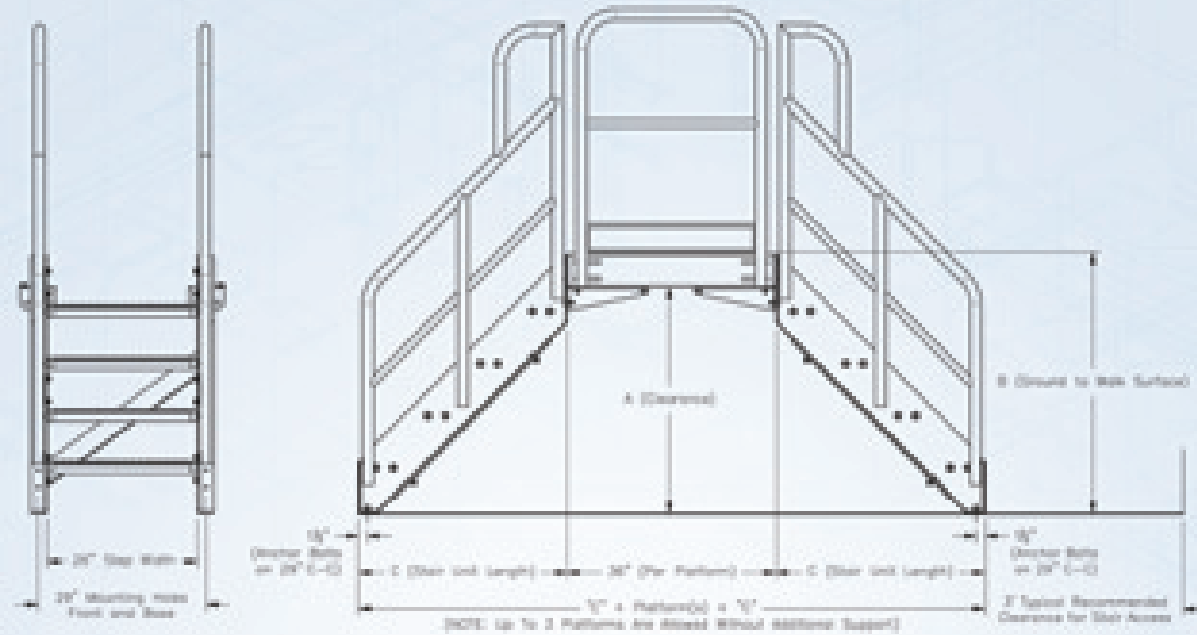

Cross-Over Clearance Table

	A (in)	B (in)	C (in)
1-Step	12	18	9
2-Step	21	27	18
3-Step	30	36	27
4-Step	39	45	36
5-Step	48	54	45
6-Step	57	63	54
7-Step	66	72	63
8-Step	75	81	72
9-Step	84	90	81
10-Step	93	99	90
11-Step	102	108	99

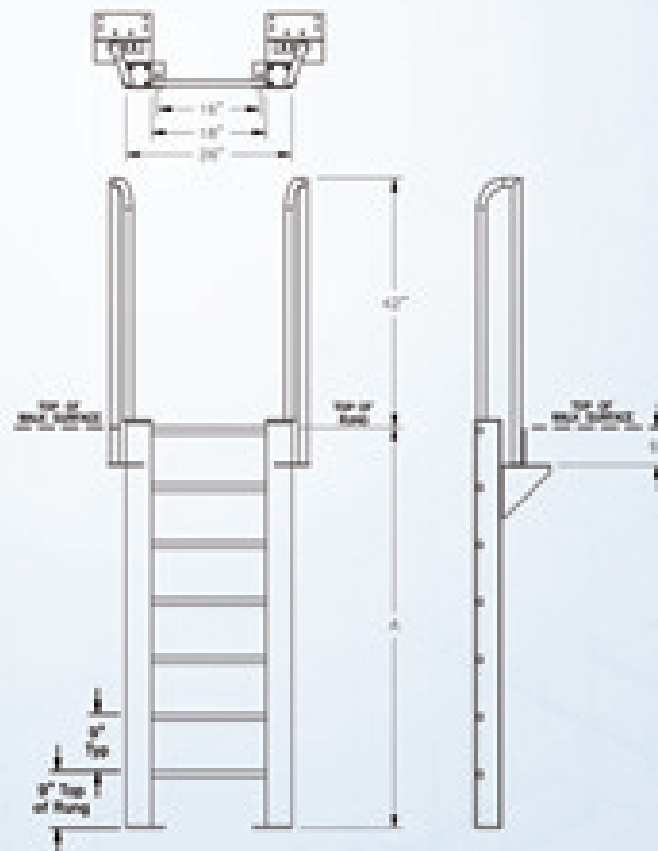

Ladder Unit Specifications

	A	Est. Weight
1-Step	18"	44 lbs.
2-Step	27"	50 lbs.
3-Step	36"	55 lbs.
4-Step	45"	60 lbs.
5-Step	54"	66 lbs.
6-Step	63"	71 lbs.
7-Step	72"	77 lbs.
8-Step	81"	82 lbs.
9-Step	90"	87 lbs.
10-Step	99"	93 lbs.
11-Step	108"	98 lbs.

Please refer to nominal dimensions provided here. If any existing obstructions are critically close to the designed limit stated, please contact us for any clarifications to insure proper fit.

APPLICABLE OSHA REGULATIONS DESIGNED TO:

OSHA 1910.23(e)(1) A standard railing shall consist of top rail, intermediate rail, and posts, and shall have a vertical height of 42 inches nominal from upper surface of top rail to floor, platform, runway, or ramp level. The top rail shall be smooth-surfaced throughout the length of the railing. The intermediate rail shall be approximately halfway between the top rail and the floor, platform, runway, or ramp. The ends of the rails shall not overhang the terminal posts except where such overhang does not constitute a projection hazard.

OSHA 1910.23(e)(5)(iv) The mounting of handrails shall be such that the completed structure is capable of withstanding a load of at least 200 pounds applied in any direction at any point on the rail.

OSHA 1910.23(e)(6) All handrails and railings shall be provided with a clearance of not less than 3 inches between the handrail or railing and any other object.

OSHA 1910.23(e)(3)(ii) For pipe railings, posts and top and intermediate railings shall be at least 1-1/2 inches nominal diameter with posts spaced not more than 8 feet on centers.

OSHA 1910.23(e)(2) A stair railing shall be of construction similar to a standard railing but the vertical height shall be not more than 34 inches nor less than 30 inches from upper surface of top rail to surface of tread in line with face of riser at forward edge of tread.

OSHA 1910.24(c) "Stair strength." Fixed stairways shall be designed and constructed to carry a load of five times the normal live load anticipated but never of less strength than to carry safely a moving concentrated load of 1,000 pounds.

OSHA 1910.24(d) "Stair width." Fixed stairways shall have a minimum width of 22 inches.

OSHA 1910.24(e) "Angle of stairway rise." Fixed stairs shall be installed at angles to the horizontal of between 30 deg. and 50 deg. Any uniform combination of rise/tread dimensions may be used that will result in a stairway at an angle to the horizontal within the permissible range. Table D-1 gives rise/tread dimensions which will produce a stairway within the permissible range, stating the angle to the horizontal produced by each combination. However, the rise/tread combinations are not limited to those given in Table D-1.

Table D-1

Angle to horizontal	Rise (in inches)	Tread run (in inches)
30 deg. 35'	6-1/2	11
32 deg. 08'	6-3/4	10-3/4
33 deg. 41'	7	10-1/2
35 deg. 16'	7-1/4	10-1/4
36 deg. 52'	7-1/2	10
38 deg. 29'	7-3/4	9-3/4
40 deg. 08'	8	9-1/2
41 deg. 44'	8-1/4	9-1/4
43 deg. 22'	8-1/2	9
45 deg. 00'	8-3/4	8-3/4
46 deg. 38'	9	8-1/2
48 deg. 16'	9-1/4	8-1/4
49 deg. 54'	9-1/2	8

OSHA 1910.24(f) "Stair treads." All treads shall be reasonably slip-resistant and the nosings shall be of non-slip finish. Welded bar grating treads without nosings are acceptable providing the leading edge can be readily identified by personnel descending the stairway and provided the tread is serrated or is of definite nonslip design. Rise height and tread width shall be uniform throughout any flight of stairs including any foundation structure used as one or more treads of the stairs.

OSHA 1910.144(a)(3) Yellow. Yellow shall be the basic color for designating caution and for marking physical hazards such as: Striking against, stumbling, falling, tripping, and "caught in between."

TERMS AND CONDITIONS

- Without a written acceptance of these conditions by the Buyer, placement of an order for any of the goods covered by this quotation will constitute acceptance of these terms and conditions. The failure to object to provisions contained in a Buyer's order or other forms of communication will not be deemed a waiver of the terms and conditions.
- ErectaStep is not responsible for delays in satisfying this order caused by circumstances which are unavoidable or beyond our control.
- Typographical errors are subject to correction.
- All information supplied to the Buyer by ErectaStep may contain proprietary design information that belongs to and shall remain property of ErectaStep. They may not be copied without the expressed written consent of an officer of ErectaStep. All information must be returned immediately upon demand.
- ErectaStep sale of goods covered by this quotation does not grant the Buyer any license or right of any kind under any patent owned or controlled by ErectaStep or under which the company is licensee.
- 2 Year Limited Warranty - See below
- Returns: Returns must be in sellable condition and authorization in writing from our office and subject to a restocking fee. Unauthorized returns will be refused. The buyer is responsible for any freight charges.
- Liens: ErectaStep provides final lien waivers when payment is received in full.
- The field measurements utilized in formulating the prices for the equipment supplied by the Buyer or their representative. Any failure of the equipment to operate satisfactorily that is caused by incorrect data and/or field measurements being supplied to the Seller by the Buyer's personnel would be at the buyer's expense. This includes any changes in operating procedures, types of vehicle being serviced, or any changes to the physical surroundings which cause conditions to be outside the original field measurements that were taken. All costs associated with those changes would be at the Buyer's expense.

OSHA 1926.451(f)(16) Platforms shall not deflect more than 1/60 of the span when loaded.

OSHA 1910.26(c)(3)(iii) The ladder base section must be placed with a secure footing.

OSHA 1910.26(c)(3)(iv) The top of the ladder must be placed with the two rails supported, unless equipped with a single support attachment.

OSHA 1910.27 Fixed ladders.

OSHA 1910.27(a) Design requirements-(1) Design considerations. All ladders, appurtenances, and fastenings shall be designed to meet the following load requirements:

OSHA 1910.27(a)(1)(i) The minimum design live load shall be a single concentrated load of 200 pounds.

OSHA 1910.27(a)(1)(ii) The number and position of additional concentrated live load units of 200 pounds each as determined from anticipated usage of the ladder shall be considered in the design.

OSHA 1910.27(a)(1)(iii) The live loads imposed by persons occupying the ladder shall be considered to be concentrated at such points as will cause the maximum stress in the structural member being considered.

OSHA 1910.27(a)(1)(iv) The weight of the ladder and attached appurtenances together with the live load shall be considered in the design of rails and fastenings.

OSHA 1910.27(b) Specific features-(1) Rungs and cleats. (i) All rungs shall have a minimum diameter of three-fourths inch for metal ladders, except as covered in paragraph (b)(7)(i) of this section and a minimum diameter of 1 1/8 inches for wood ladders.

OSHA 1910.27(b)(1)(ii) The distance between rungs, cleats, and steps shall not exceed 12 inches and shall be uniform throughout the length of the ladder

OSHA 1910.27(b)(1)(iii) The minimum clear length of rungs or cleats shall be 16 inches

OSHA 1910.27(b)(2) Side rails. Side rails which might be used as a climbing aid shall be of such cross sections as to afford adequate gripping surface without sharp edges, splinters, or burrs.

OSHA 1910.27(b)(6) Welding. All welding shall be in accordance with the "Code for Welding in Building Construction" (AWS D1.0-1966).

OSHA 1910.27(c)(5) Clearance in back of grab bar. The distance from the centerline of the grab bar to the nearest permanent object in back of the grab bars shall be not less than 4 inches. Grab bars shall not protrude on the climbing side beyond the rungs of the ladder which they serve.

OSHA 1910.27(d)(2)(iii) One rung of any section of ladder shall be located at the level of the landing laterally served by the ladder. Where access to the landing is through the ladder, the same rung spacing as used on the ladder shall be used from the landing platform to the first rung below the landing.

OSHA 1910.27(d)(3) Ladder extensions. The side rails of through or side-step ladder extensions shall extend 3 1/2 feet above parapets and landings. For through ladder extensions, the rungs shall be omitted from the extension and shall have not less than 18 nor more than 24 inches clearance between rails. For side-step or offset fixed ladder sections, at landings, the side rails and rungs shall be carried to the next regular rung beyond or above the 3 1/2 feet minimum. (fig. D-10).

OSHA 1910.27(d)(4) Grab bars. Grab bars shall be spaced by a continuation of the rung spacing when they are located in the horizontal position. Vertical grab bars shall have the same spacing as the ladder side rails. Grab-bar diameters shall be the equivalent of the round-rung diameters.

- Buyer assumes liability for patent and copyright infringement when goods are made to Buyer's specifications.
- If the Buyer cancels an order prior to its completion, the Buyer agrees to pay to Seller the percentage of the selling price based on the percentage of the completion, plus any costs for the disposal of used material. The Seller would determine the percentage of completion.
- Indemnity: Buyer shall indemnify and hold harmless ErectaStep, its affiliated companies, owners, employees, agents, and successors from and against any and all claims, expenses, liability, and loss arising from claims for injury, death, or damage to, or destruction of property arising from unauthorized repair or modifications to the products provided under this purchase order/quotation, as well as failure to properly maintain said products, improper use of said products, use of said products for anything other than their intended purpose, and/or the equipment not working or functioning properly caused by a change in working parameters that were unknown by ErectaStep.

WARRANTY
ErectaStep prides itself on its workmanship and quality. We strive for perfection in each and every part that we manufacture. All ErectaStep parts are warranted for 2 years against defects. Abuse, extraordinary corrosion, improper installation and other things out of control of ErectaStep are not covered under warranty. Warranty is limited to repair or replacement parts shipped ground to destination as determined by ErectaStep. No additional costs incurred due to warranty related parts are covered i.e. labor, loss of use.

INTENDED USE
All ErectaStep parts are pre-engineered with specific purpose for safe access and egress. It is very important to follow configuration guidelines as well as installation instructions provided with order. Design limitations can exist with respect to required supports, adequate footings and prescribed application. Applied loads beyond the stated design loads and use not as advertised are also not covered under the warranty. Any alteration in design or intended use or purpose beyond ErectaStep's recommendations or knowledge voids our warranty and liability against all claims. ErectaStep offers free design assistance to insure a safe, successful outcome to your project.